



BTA20 BW/CW BTB20 BW/CW

SNUBBERLESS TRIACS

FEATURES

- High commutation: $(di/dt)_c > 18A/ms$ without snubber
- High surge current: $I_{TSM} = 200A$
- V_{DRM} up to 800V
- BTA Family:
Insulating voltage = $2500V_{(RMS)}$
(UL recognized: E81734)

DESCRIPTION

The BTA/BTB20 BW/CW triac family are high performance glass passivated chips technology. The SNUBBERLESS™ concept offer suppression of RC network and it is suitable for application such as phase control and static switching on inductive or resistive load.

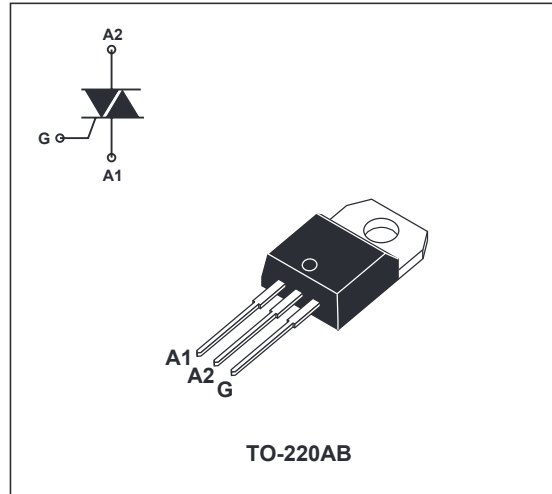

ABSOLUTE RATINGS (limiting values)

Symbol	Parameter		Value	Unit	
$I_{T(RMS)}$	RMS on-state current (360° conduction angle)	BTA	$T_c = 70^\circ C$	20	A
		BTB	$T_c = 90^\circ C$		
I_{TSM}	Non repetitive surge peak on-state current (T_j initial = $25^\circ C$)		$t_p = 8.3ms$	210	A
			$t_p = 10ms$	200	
I^2t	I^2t value		$t_p = 10ms$	200	A^2s
di/dt	Critical rate of rise of on-state current Gate supply: $I_G = 500mA$ $di_G/dt = 1A/\mu s$		Repetitive $F = 50Hz$	20	$A/\mu s$
			Non repetitive	100	
T_{stg} T_j	Storage and operating junction temperature range			-40 to +150 -40 to +125	$^\circ C$
TI	Maximum lead soldering temperature during 10s at 4.5mm from case			260	$^\circ C$

Symbol	Parameter	BTA/BTB20-...BW/CW		Unit
		600	700	
V_{DRM} V_{RRM}	Repetitive peak off-state voltage $T_j = 125^\circ C$	600	700	V

BTA20 BW/CW BTB20 BW/CW

THERMAL RESISTANCE

Symbol	Parameter	Value	Unit
Rth (j-a)	Junction to ambient	60	°C/W
Rth (j-c) DC	Junction to case for DC	BTA	2.8
		BTB	1.7
Rth (j-c) AC	Junction to case for 360° conduction angle (F = 50Hz)	BTA	2.1
		BTB	1.3

GATE CHARACTERISTICS (maximum values)

$P_{G(AV)} = 1W$ $P_{GM} = 10W$ ($t_p = 20\mu s$) $I_{GM} = 4A$ ($t_p = 20\mu s$) $V_{GM} = 16V$ ($t_p = 20\mu s$)

ELECTRICAL CHARACTERISTICS

Symbol	Test conditions		Quadrant		BTA / BTB20		Unit
					BW	CW	
I_{GT}	$V_D = 12V$ (DC) $R_L = 33\Omega$	$T_j = 25^\circ C$	I - II - III	MIN.	2	1	mA
				MAX.	50	35	
V_{GT}	$V_D = 12V$ (DC) $R_L = 33\Omega$	$T_j = 25^\circ C$	I - II - III	MAX.	1.5		V
V_{GD}	$V_D = V_{DRM}$ $R_L = 3.3k\Omega$	$T_j = 125^\circ C$	I - II - III	MIN.	0.2		V
tgt	$V_D = V_{DRM}$ $I_G = 500mA$ $di_G/dt = 3A/\mu s$	$T_j = 25^\circ C$	I - II - III	TYP.	2		μs
I_L	$I_G = 1.2I_{GT}$	$T_j = 25^\circ C$	I - III	TYP.	50	-	mA
			II		90	-	
			I - II - III	MAX.	-	80	
I_H^*	$I_T = 500mA$ Gate open	$T_j = 25^\circ C$		MAX.	75	50	mA
V_{TM}^*	$I_{TM} = 28A$ $t_p = 380\mu s$	$T_j = 25^\circ C$		MAX.	1.70		V
I_{DRM} I_{RRM}	V_{DRM} rated V_{RRM} rated	$T_j = 25^\circ C$		MAX.	0.01		mA
		$T_j = 125^\circ C$		MAX.	3		
dV/dt *	Linear slope up to $V_D = 67\% V_{DRM}$ gate open	$T_j = 125^\circ C$		TYP.	750	500	V/ s
				MIN.	500	250	
(di/dt)c*	Without snubber	$T_j = 125^\circ C$		TYP.	36	22	A/ms
				MIN.	18	11	

* For either polarity of electrode A₂ voltage with reference to electrode A₁

PRODUCT INFORMATION

Package	$I_{T(RMS)}$	V_{DRM} / V_{RRM}	Sensitivity Specification	
	A	V	BW	CW
BTA (Insulated)	20	600	X	X
		700	X	X
BTB (Uninsulated)		600		X

ORDERING INFORMATION

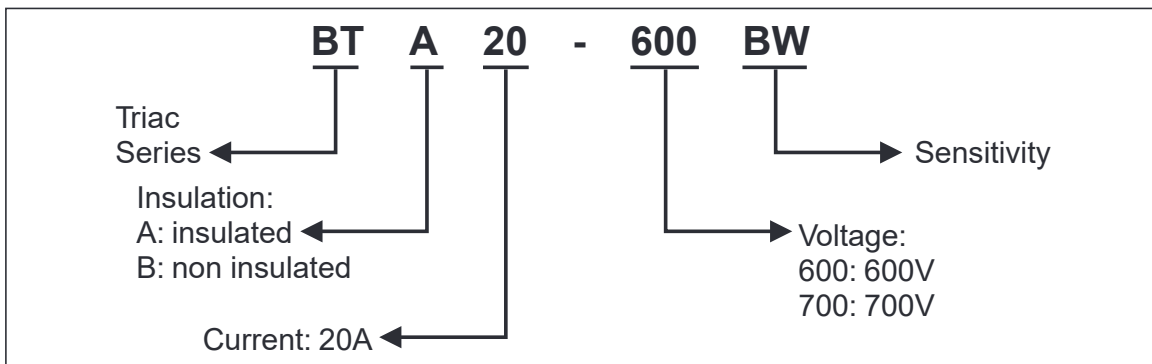

Fig. 1: Maximum RMS power dissipation versus RMS on-state current ($F = 50\text{Hz}$). (Curves are cut off by $(di/dt)_c$ limitation)

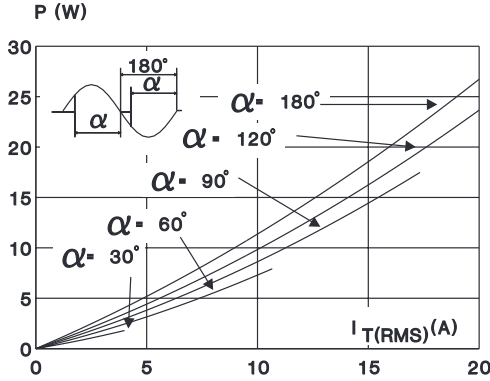

Fig. 2: Correlation between maximum RMS power dissipation and maximum allowable temperatures (T_{amb} and T_{case}) for different thermal resistances heatsink + contact (BTA).

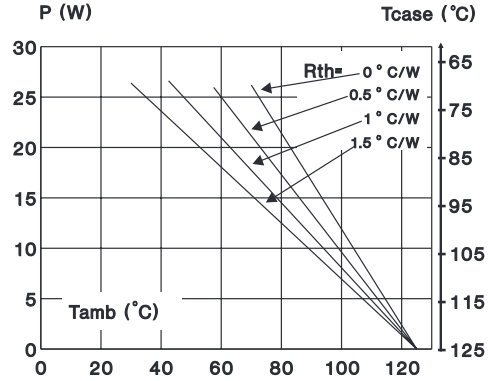

Fig. 3: Correlation between maximum RMS power dissipation and maximum allowable temperatures (T_{amb} and T_{case}) for different thermal resistances heatsink + contact (BTB).

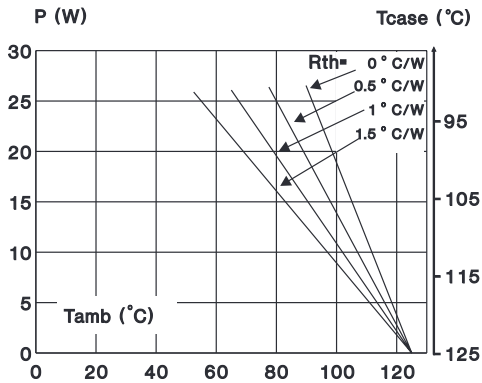

Fig. 4: RMS on-state current versus case temperature.

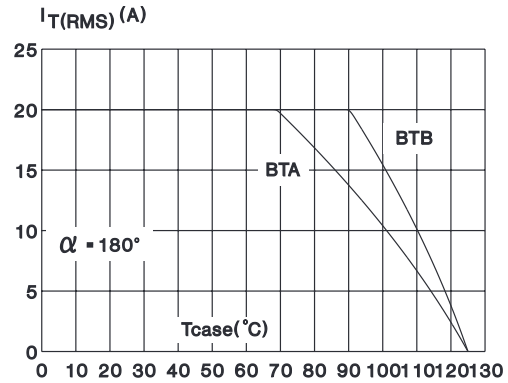

Fig. 5: Relative variation of thermal impedance versus pulse duration.

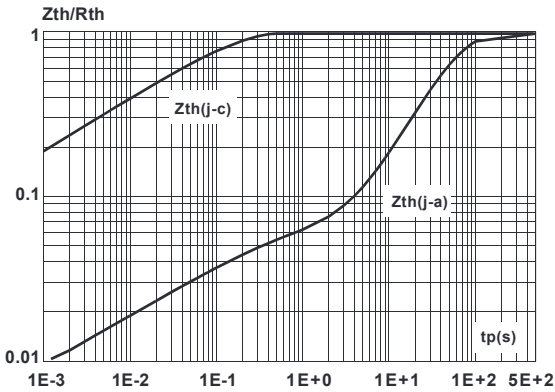

Fig. 6: Relative variation of gate trigger current and holding current versus junction temperature.

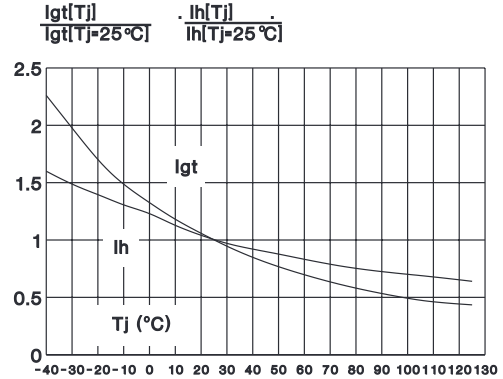

Fig. 7: Non repetitive surge peak on-state current versus number of cycles.

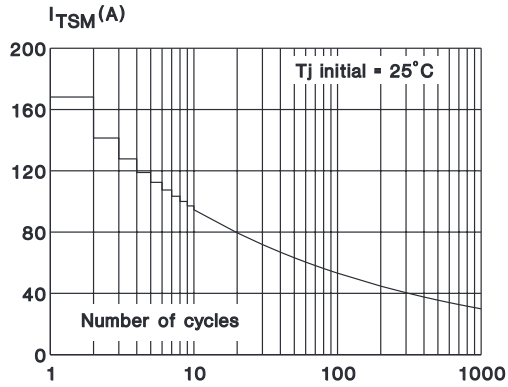

Fig. 8: Non repetitive surge peak on-state current for a sinusoidal pulse with width: $t \leq 10\text{ms}$, and corresponding value of I^2t .

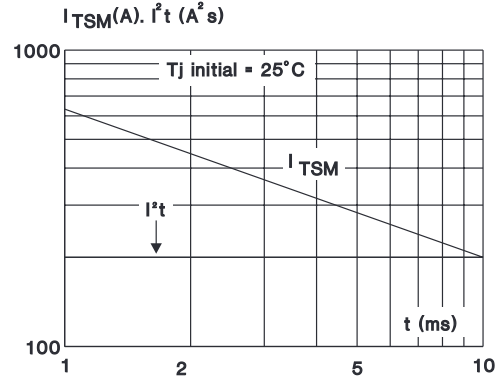
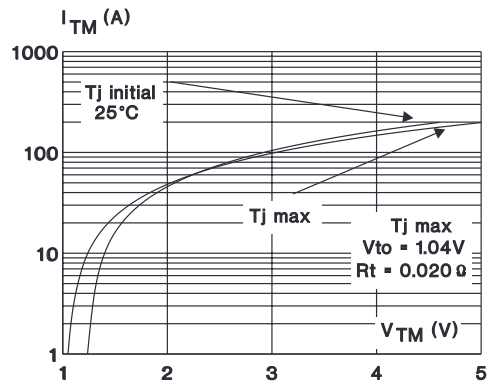
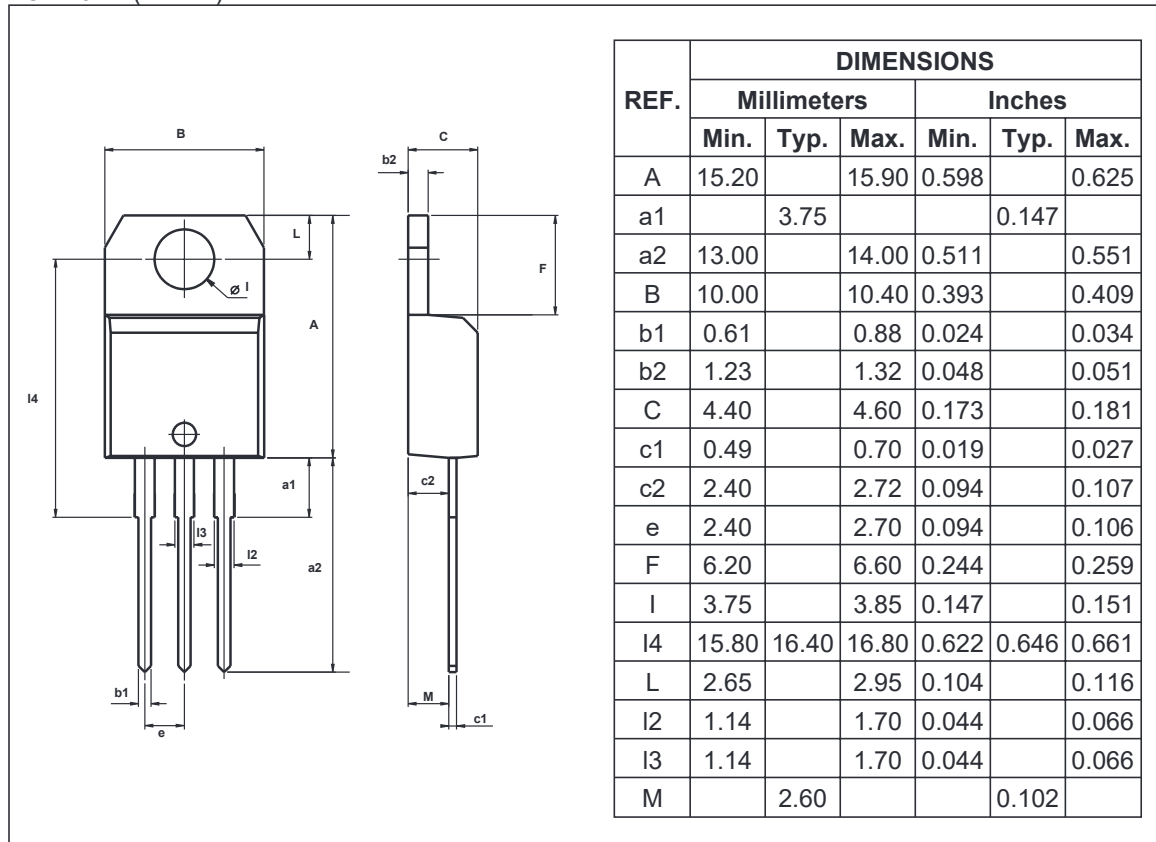

Fig. 9: On-state characteristics (maximum values).



BTA20 BW/CW BTB20 BW/CW

PACKAGE MECHANICAL DATA TO-220AB (Plastic)



OTHER INFORMATION

Ordering type	Marking	Package	Weight	Base qty	Delivery mode
BTA/BTB20-xxxxyz	BTA/BTB20-xxxxyz	TO-220AB	2.3 g	250	Bulk

- Epoxy meets UL94,V0
- Cooling method: C
- Recommended torque value: 0.8 m.N.
- Maximum torque value: 1 m.N.

Information furnished is believed to be accurate and reliable. However, STMicroelectronics assumes no responsibility for the consequences of use of such information nor for any infringement of patents or other rights of third parties which may result from its use. No license is granted by implication or otherwise under any patent or patent rights of STMicroelectronics. Specifications mentioned in this publication are subject to change without notice. This publication supersedes and replaces all information previously supplied. STMicroelectronics products are not authorized for use as critical components in life support devices or systems without express written approval of STMicroelectronics.

The ST logo is a registered trademark of STMicroelectronics

© 2001 STMicroelectronics - Printed in Italy - All rights reserved.

STMicroelectronics GROUP OF COMPANIES

Australia - Brazil - China - Finland - France - Germany - Hong Kong - India - Italy - Japan - Malaysia
Malta - Morocco - Singapore - Spain - Sweden - Switzerland - United Kingdom - U.S.A.

<http://www.st.com>